

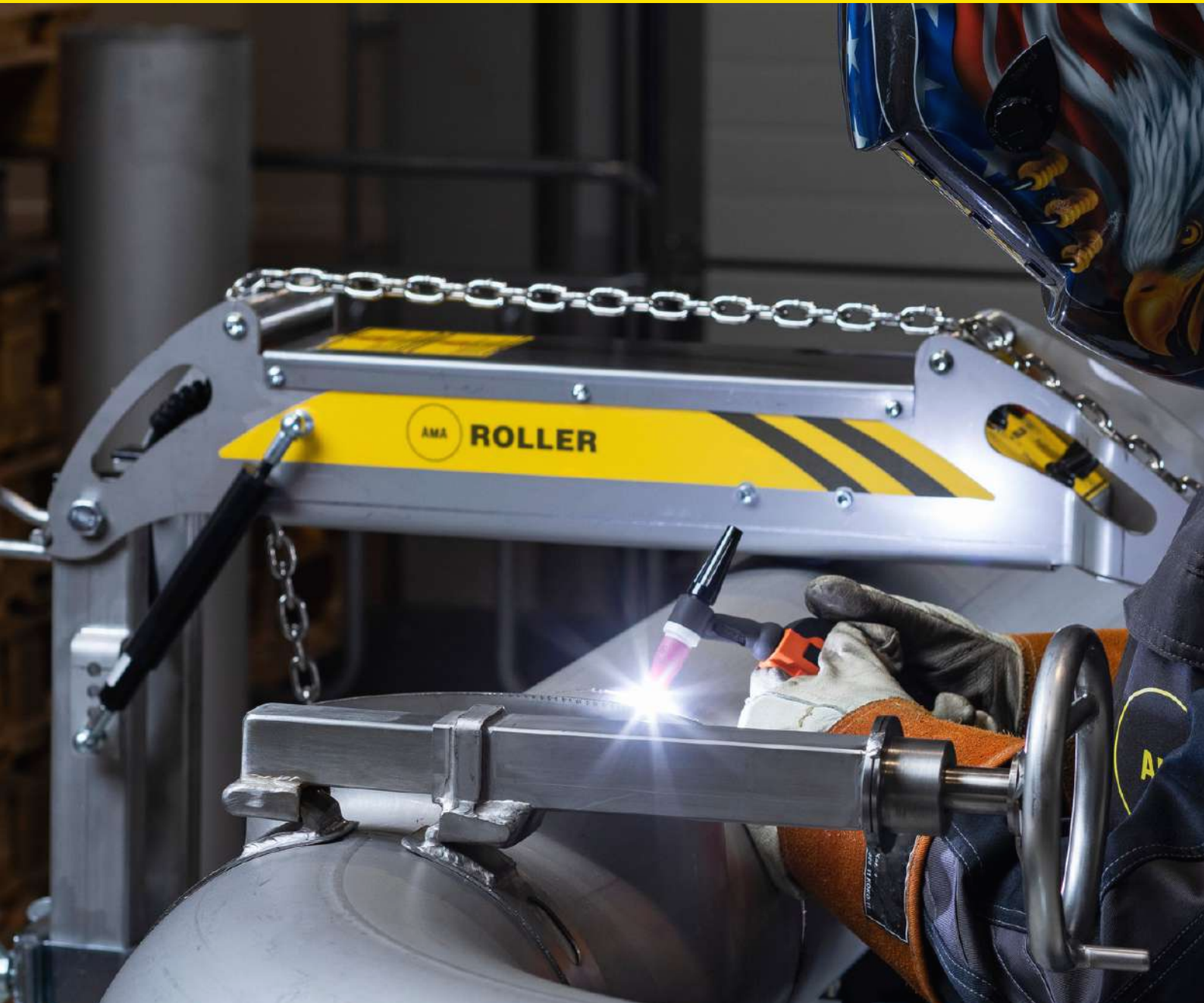

PIPE WELDING TOOLS



BETTER PROFITABILITY

BETTER ERGONOMICS

BETTER QUALITY





Pipe welding stands



Pipe stand set for pipe welding, including stands A, B and C

PRODUCT CODE 2040

- Stable, durable and mobile pipe stands
- Adjustable heights
- Galvanised frames and frame components

Accessories for AMA pipe stands:

Purge Gas Manual TIG Turntables for Stand A

- Hand-rotated
- Gas supply from the center of the tabletop
- Round tabletop of stainless steel, rotates on ball bearings

AMA turntable 200 (4030)

- For pipes up to DN200 (8")

AMA turntable 400 (4040)

- For pipes up to DN400 (16")

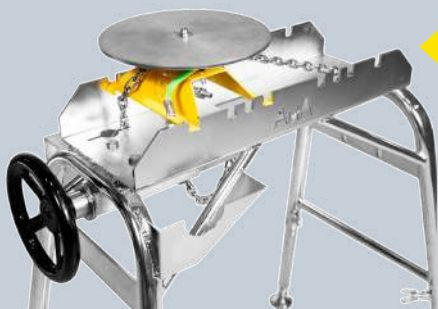

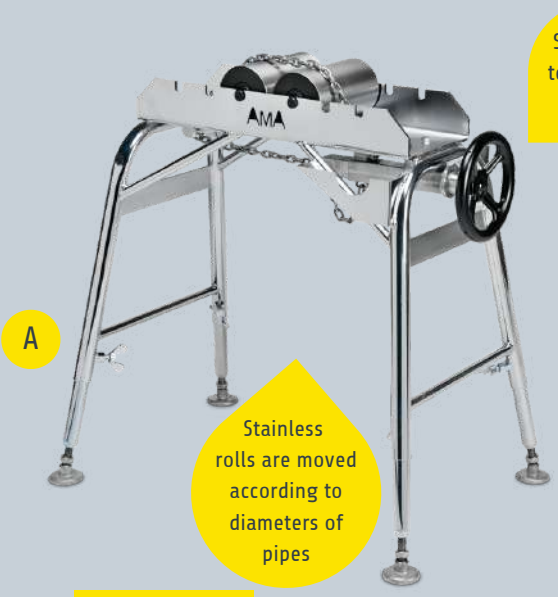

A

Stainless rolls are moved according to diameters of pipes

Stainless tensioning chain

Product code 1010



B

Stainless balls are moved according to diameters of pipes

Product code 1020



C

Convenient aid stand

Product code 1030

PIPE WELDING STAND A (1010)

- Stainless steel rolls
- Stainless steel tensioning chain
- Adjustable height: 840-1100 mm
- Maximum load-bearing capacity 1,500 kg
- Application with chain tensioning: 15 - 720 mm pipes
- Application without chain tensioning: 700-1000 mm pipes
- Weight 33kg

PIPE WELDING STAND B (1020)

- Stainless steel ball rollers
- Adjustable height: 800-1100 mm
- Maximum load-bearing capacity 560 kg
- Application: pipe sizes 15 - 720mm
- Weight 14 kg

PIPE WELDING STAND C (1030)

- Aid stand
- Adjustable height: 800-1200 mm
- Adjustable height also when the pipe is on the stand
- Maximum load-bearing capacity 560 kg
- Application: pipe sizes 15 - 720 mm
- Weight 6 kg

Accessories for AMA pipe stands:

For rolls of stand A



Rubber ring set Product code 4006

E.g. for thick-seamed pipes

RUBBER RING DAMPER SET FOR AMA STAND A ROLLERS (4006)

- 4 rubber rings and adhesive

GALVANISED SHELF FOR STAND A (4006)

- Handy for tools



Shelf for stand A Product code 4020

POLYURETHANE ROLLERS FOR STAND B

Plain bearing (4008)

Ball bearings (4009)

- Also includes storage hooks

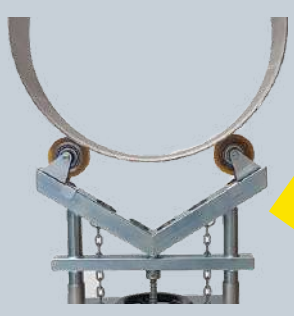

Does not scratch the pipe

Stand B wheels

Product codes 4008 and 4009



Centering Collars

Basic centering collar set

Product code 3040



Mini centering collar set

Product code 3060



Centering Collars

Extremely quick, accurate and easy-to-use centering collars for pipes. Reduces installation and welding errors to a minimum.

Basic centering collar set

PRODUCT CODE 3040

- Includes 7 pcs collars and one collar tightener
- Includes the following collars:
DN150, DN200, DN250, DN300,
DN/NS 350, DN/NS 400 and DN/NS 500
- Includes a normal collar tightener (3010)

Mini centering collar set

PRODUCT CODE 3060

- Includes the collars DN65, DN80, DN100 and DN125
- Includes a mini collar tightener (3030)
- Includes a collar holder for toolbox (3050)



Collar tighteners



Collar tighteners

A collar tightener is used to tighten the collar so that centering the pipes is as accurate as possible.

Earn more
by optimising working
methods and
equipment



Mini collar tightener
Product code 3030
Recommendation: DN65-DN150

Large collar tightener
Product code 3020
Recommendation: DN/NS 600 - DN/NS 1500

Normal collar tightener
Product code 3010
Recommendation: DN 150-DN/NS 500

LARGE COLLAR TIGHTENER (3020)

- Manufacturing material stainless steel
- Thrust bearings
- Recommended for collar sizes DN/NS 600 and larger ones
- Weight 2.4 kg
- 50 mm longer tensioning length
- Stronger torque
- Also better suited for thick-walled pipes

NORMAL COLLAR TIGHTENER (3010)

- Manufacturing material stainless steel
- Thrust bearings
- Recommended for collar sizes DN150 - DN/NS 500
- Weight 2.3 kg

MINI COLLAR TIGHTENER (3030)

- Manufacturing material stainless steel
- Thrust bearings
- Recommended for collar sizes DN65 - DN150
- Weight 0.9 kg, light to handle
- Small and convenient collar tightener on the side





Collar sizes

Choose a suitable AMA centering collar here:

Product code	DN size	Inch size	AMA centering collars DN / inch:	Pipe OD Min mm	Max mm
1065	65	2,5"	DN65 Acid resistant collar with hinge	73	82
1080	80	3"	DN80 Acid resistant collar with hinge	85	90
1100	100	4"	DN100 Acid resistant collar	110	120
1125	125	5"	DN125 Acid resistant collar	138	145
1150	150	6"	DN150 Acid resistant collar	165	175
1200	200	8"	DN200 Acid resistant collar	215	225
1250	250	10"	DN250 Acid resistant collar	270	285
1300	300	12"	DN300 Acid resistant collar	320	330
1350	350	14"	DN/NS 350 Acid resistant collar	354	365
1400	400	16"	DN/NS 400 Acid resistant collar	400	420
1450	450	18"	DN/NS 450 Acid resistant collar	445	465
1500	500	20"	DN/NS 500 Acid resistant collar	500	520
1600	600	24"	DN/NS 600 Acid resistant collar, two part	600	630
1700	700	28"	DN/NS 700 Acid resistant collar, two part	700	730
1800	800	32"	DN/NS 800 Acid resistant collar, two part	800	830
1900	900	36"	DN/NS 900 Acid resistant collar, two part	900	930
11000	1000	40"	DN/NS 1000 Acid resistant collar, two part	1000	1030
11100	1100	44"	DN/NS 1100 Acid resistant collar, two part	1100	1130
11200	1200	48"	DN/NS 1200 Acid resistant collar, two part	1200	1230
11300	1300	52"	DN/NS 1300 Acid resistant collar, two part	1300	1330
11400	1400	56"	DN/NS 1400 Acid resistant collar, two part	1400	1430
11500	1500	60"	DN/NS 1500 Acid resistant collar, two part	1500	1530

Product code	AMA Centering collars with NS measurements:	Pipe OD Min mm	Max mm
1100NS	NS100 Acid resistant collar with hinge	100	110
1125NS	NS125 Acid resistant collar	125	137
1150NS	NS150 Acid resistant collar	150	165
1200NS	NS200 Acid resistant collar	200	215
1250NS	NS250 Acid resistant collar	250	265
1300NS	NS300 Acid resistant collar	300	315

Note! Collars from 350 are suitable for both NS and DN dimensioning.

Collar types



HINGE COLLARS

- Sizes DN65, DN80
- Recommended collar tightener: 3030

ONE-PART COLLARS

- Sizes DN100 - DN/NS 500
- Recommended collar tightener: 3010

TWO-PART COLLARS

- Sizes DN/NS 600 - DN/NS 1500
- Recommended collar tighteners: 3020

Collar holder for toolbox

PRODUCT CODE 3050

The collar holder allows collars and the collar tightener to be conveniently hung on the outside of the toolbox. The holder is locked when the lid of the toolbox is locked.



Product code 3050



Counterweight system



Counterweight system

PRODUCT CODE 4000

With the help of AMA centering collars, a quickly attachable counterweight system facilitates prefabrication and welding of heavy pipe curve projections.

Contains:

- Counterweight attachment:
 - manufacturing material: stainless steel and galvanised steel, thrust bearings
- Weights are made of galvanised steel, approx. 9 kg/pc (4 pcs)
- Carry holder for weights
- Total weight 43 kg





AMA Roller®

AMA Roller® Pipe rotator

PRODUCT CODE 7010 AND 7040

Efficient and compact pipe rotator which is suitable for both construction sites and prefabrication workshops. The AMA Roller® rotates pipes at the selected speed.

- Increases the speed and efficiency of a pipe welder's work
- Improves profitability
- Improves the quality of the welding seam
- Improves ergonomics
- Reduces starts and stops
- Reduces differences in skill levels between different welders
- Weight 23 kg + pipe stand A 33 kg
- Maximum rotating load 30 Nm
- Suitable for all manual welding methods: MIG, MAG, TIG and MMA
- Manufactured in Finland

PATENTED

Improves efficiency by up to 30%

Ergonomic welding position



AMA Roller + Stand A and B

Product code 7040

Foot pedal operation

Rotating speed and direction adjustable



Attachment with quick fasteners to the A stand





AMA Roller®

The AMA Roller® rotates pipes when:

- You use an angle grinder to cut
- You tack-weld
- You weld
- You clean the base
- You brush an stainless/acid resistant seam
- You weld difficult materials



Suitable for
pipe diameters
30-508 mm

AMA Roller + Stand A

Product code 7010



Light and
easy to
move

Reduces
errors

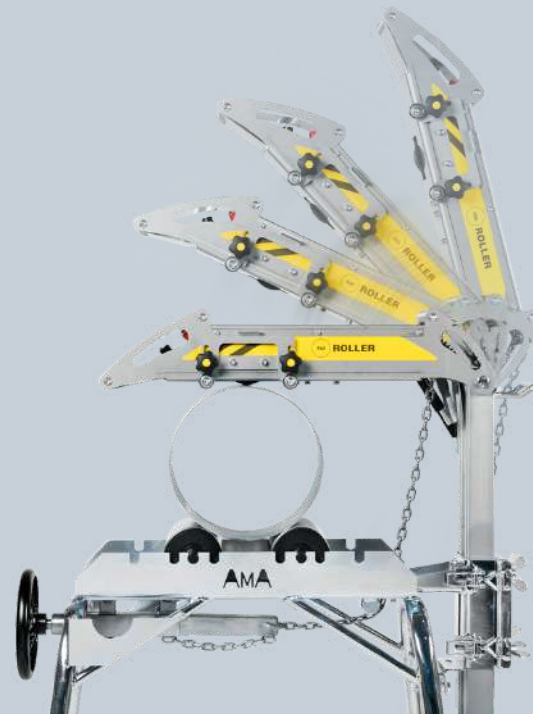
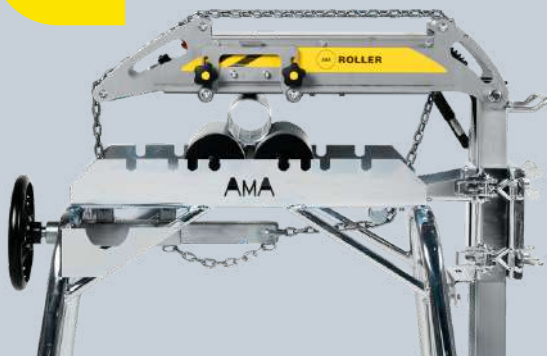

Easy to turn
to a vertical
position





AMA Roller®



Specifications

- Patented
- CE-marked
- Weight 23 kg + pipe stand A 33 kg
- Nominal voltage 110 V
- Current 0.9 A
- Frequency 50/60 Hz
- Power 100 W
- Diameter range of pipes to be rotated 30-500 mm
- Maximum rotation load 30 Nm
- Maximum rotation speed 1.25 m/min

Examples of AMA Roller®'s maximum rotation load (30Nm):

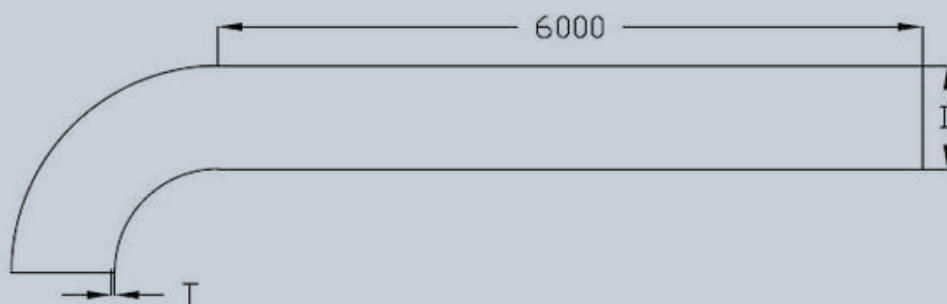

Example: pipe 6 m + curve (curve radius = 1.5 x pipe diameter)

Pipe diameter (D): Max wall thickness (T):

30 - 300 mm 10 mm

350 mm 8 mm

400 mm 6 mm

500 mm 4 mm





The AMA Roller® annually increases the efficiency of welding production by up to 30%

The device simply makes our welding and installation work easier and more efficient. I have assessed and calculated that its use boosts our welding production up to 30% at the annual level.

What's more, it promotes physical occupational wellness and makes work more enjoyable. Our employees do not want to quit using the product, and this says much about the Roller's significance. Compared with other equivalent devices, the practicality of this device is superior. The welder always takes AMA Roller® along to job sites like ordinary pipe stands. But now the stand has a pipe rotator, so rotating happens with the same device.

Paul Heiskanen, KPH Tech Oy



Professionals can focus on the essential

Our experiences in using the device have all been positive. In our prefabrication workshop we typically handle 200–250-mm pipes, which AMA Roller is able to rotate in daily use without any kinds of problems. With several AMA Rollers our manual welding production has speeded up significantly, since the welders are able to concentrate on the essential, and the improved quality also lessens the need for finishing and fixing.

Earlier we used welding positioners to rotate pipes, but AMA Roller is a significant innovation in this sector. I haven't seen such a lightweight, functional, and easy-to-use device on the market before.

Jaakko Pietilä, Fineweld Oy



**"The AMA Roller® improves our efficiency
by up to 30%"**

**"The device simply facilitates and
increases the efficiency of our welding
and installation work"**

**"The speed of our manual welding
production has increased significantly"**

**"The improved quality also reduces the
need for finishing and repair work"**

**"AMA Roller rotates all types of
components, which
used to require manual work"**

Retailer:

 WILKINSON STAR

Exclusive UK & Ireland Importer:

Wilkinson Star Ltd

0161-793-8127

sales@wilkinsonstar247.com - www.wilkinsonstar247.com



Manufacturer:

Welner Oy, Finland

www.welner.fi